

FlexPRESS *Mounting Press*

MOUNTING

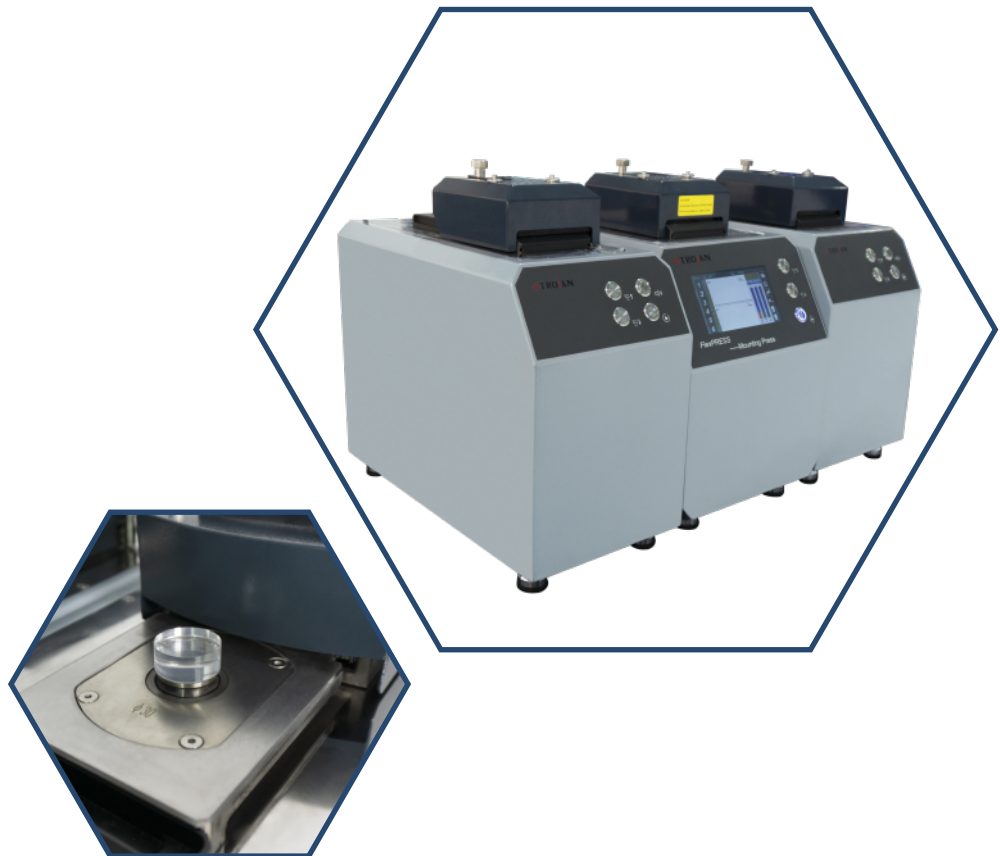

2024
10 / 11

FlexPRESS Mounting Press

FlexPRESS is a flexible hot mounting machine which has modular unit design. It consists of base unit and mounting units. One host can be configured with up to 5 mounting units. This machine can meet the needs of different customers for specimen mounting, and can realize batch mounting operations.

Features:

- ◆ Modular units design; basic with additional pressing units are optional;
- ◆ Sliding cap, can be opened & closed automatically or manually;
- ◆ Equipped with 7" touch screen on basic unit and store 16 user-defined programs;
- ◆ Can be heated on the top & surround, Realize rapid heating of the sample and improve efficiency;
- ◆ Pre-heating& pre-pressurized function with adjustable heating power (speed);
- ◆ Optional circulating water tank to achieve a variety of cooling methods.

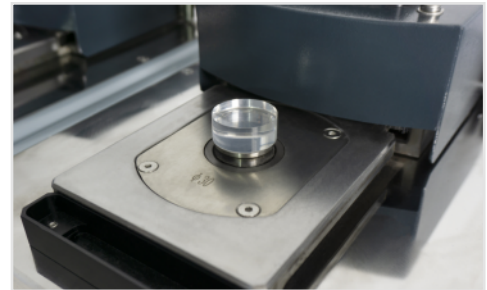

Technical Data:

Model	FlexPRESS Basic unit	FlexPRESS Extended unit
Voltage	110/220V	
Heating Power	2.0Kw	
Mold Size	Φ30mm(Standard), Φ25.4mm, Φ32mm, Φ40mm, Φ50mm(Optional)	
Heating Range	60~250°C	
Holding Time	1 ~ 60Min	
Safety	0~500Bar (Depending on the mold size)	
Heating Position	Heating from around and top	
Heating Method	First preheating, then insulation or without preheating	
Pressurized Method	Pre-pressurize first, then hold the pressure (also without pre-pressure)	
Cooling Mode	Auto:by temperature or time.manual mode	
Cooling Rate	High, medium and low	
Control Panel	7-inch touch screen	Push buttons
Environment Temperature	-20°C - 60°C	
Environment Humidity	0-95%RH	
Dimesion (WxDxH)	300×561×492mm	254×550×492mm
Weight	60Kg	52Kg

Related Consumables & Accessories:

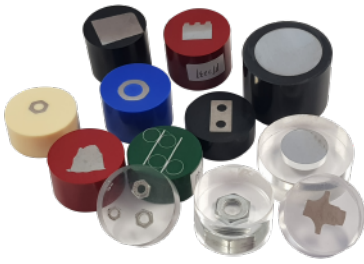

Hot Mounting Consumables



Mineral & Glass Fiber Filled Epoxy Resin









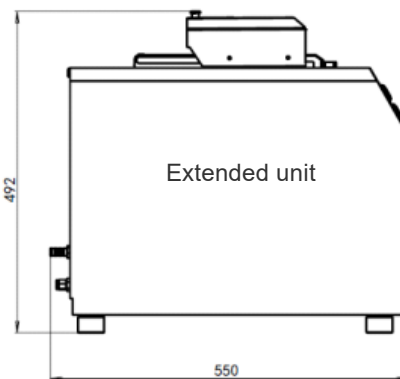
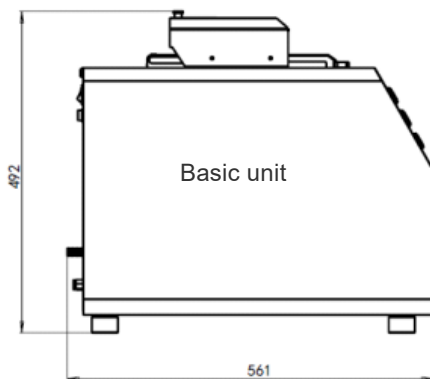
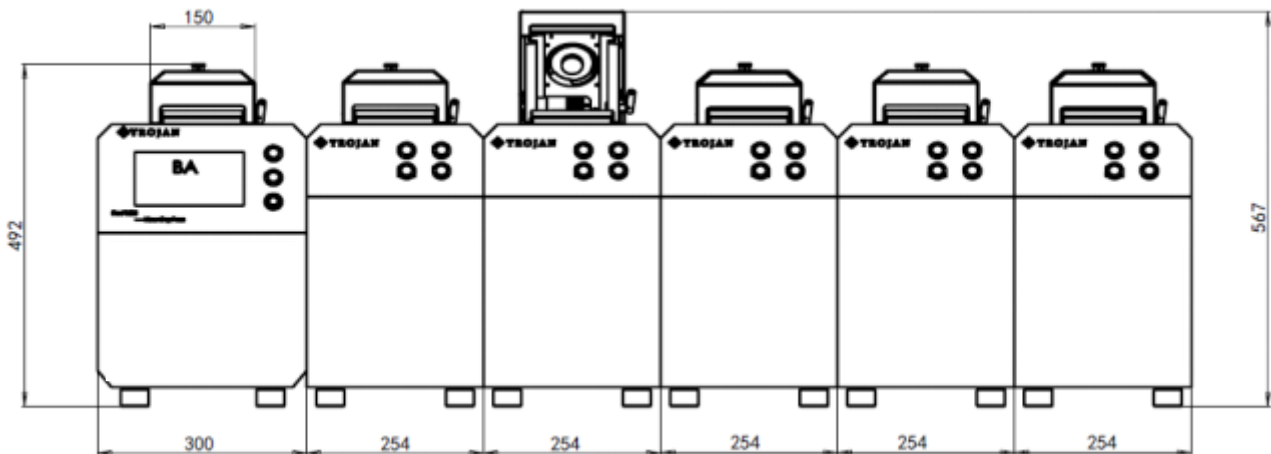



Sample Support Clip

Dimension Figure





Unite: mm



Standard Accessories:

1	Water inlet pipe		Φ8mmPU pipe	1pc
2	Water outlet pipe		Inner diameter 12mm, outer diameter 21mm, drain hose and hose clamp	1set
3	Hot mounting compounds		PT-2231,300g	1bottle
4	Spoon			1pc
5	Funnel			1pc
6	Cleaning brush			1pc
7	Storage box			1pc
8	Shovel			1pc
9	Allen key		M5 Allen key	1pc
10	Power cable		220V, 16A, 1.5Mhigh-power power cable	1pc

Optional Accessories:

1	Extended unit		FlexPRESS extended unit	1pc
2	Circulating tank		Filtank60	1set
3	Sleeve and the rams		Φ25.4、Φ30、Φ32、Φ40、Φ50	1set
4	Mold release			1bottle
5	Brass spacer		Φ25.4、Φ30、Φ32、Φ40、Φ50	1pc

Purchase list:

Hot Mounting Consumables:

02.01.310/320	PT-2231 Phenolic Resin Black (Daily Use)	1kg/4kg
02.01.311/321	PT-2231 Phenolic Resin Green (Daily Use)	1kg/4kg
02.01.312/322	PT-2231 Phenolic Resin Red (Daily Use)	1kg/4kg
02.01.210/220	BB-2232 Phenolic Edge Protection Resin	1kg/4kg
02.01.110/120	TM-2235 Transparent Resin	1kg/4kg
02.01.710/720	EP-2237 Mineral & Glass Fiber Filled Epoxy Resin	1kg/4kg
02.01.910/940	DC-2239 Graphite Conductivity Hot Insert Resin	1kg/4kg
02.01.960/965	MA-2275 Mineral filled Melamine Resin	1kg/4kg

Accessories for hot mounting:

12.01.042	Mold release agent	100g
07.01.016	Stainless Steel Clip	100pcs



TROJAN (SUZHOU) MATERIAL TECHNOLOGY CO.,LTD

Tel: +86-512-65283666

Email: sales@trojanchina.com

Web: www.trojanworld.com

Add: Building 26, No.228 Gongtang Road, Luzhi Town, Wuzhong Suzhou, China

